

# HD2 Series

## AC Variable Speed Inverters

3 Phase 380/440V 50/60Hz 1.5~500kW



- Torque Vector control
- Up to 150% starting torque
- HD rated for demanding applications
- Asynchronous & synchronous motor control
- Advanced LCD keypad (16 lines of text)
- Motor Auto-tune (static and dynamic)
- Safe Torque Off (STO)
- 2 motor parameter sets.
- DC Injection braking
- Flux braking
- Integral brake chopper (<37kW)
- Integral AC reactor (>355Kw)
- Integral DC reactor (18.5~110Kw)
- PID Control as standard
- Modbus RTU/RS485 built in
- PG Encoder control
- IP20 (all models)
- Wifi card
- Bluetooth card
- Profibus DP card
- CANopen card
- Profinet card.
- Multi I/O card
- 6 Digital Inputs
- 2 Analogue Inputs
- 1 Analogue Output
- 2 Relay Outputs
- 2 Digital Outputs
- Integral C3 filter
- Category C1 & C2 filter options
- CE & RCM Marked
- 2 Year warranty



### Ordering Information

		<b>HD2</b>	-	<b>75A</b>	-	<b>43</b>		
Series		HD2 Inverter Drive		HD2		Input 440V Three Phase		
<b>Output Power kW (HP)</b>								
1.5kW	(2HP)			3.7A	90kW	(125HP)	180A	
2.2kW	(3HP)			5A	110kW	(150HP)	215A	
4.0kW	(5.5HP)			9.5A	132kW*	(175HP)	260A	
5.5kW	(7.5HP)			14A	160kW*	(215HP)	305A	
7.5kW	(10HP)			18.5A	185kW*	(250HP)	340A	
11kW	(15HP)			25A	200kW*	(270HP)	380A	
15kW	(20HP)			32A	220kW*	(300HP)	425A	
18.5kW	(25HP)			38A	250kW*	(335HP)	480A	
22kW	(30HP)			45A	280kW*	(375HP)	530A	
30kW	(40HP)			60A	315kW*	(420HP)	600A	
37kW	(50HP)			75A	355kW*	(475HP)	650A	
45kW	(60HP)			92A	400kW*	(535HP)	720A	
55kW	(75HP)			115A	450kW*	(600HP)	820A	
75kW	(90HP)			150A	500kW*	(670HP)	860A	

\* All models 132kW and above are UL/cUL approved

# HD2 Series

## AC Variable Speed Inverters



Technical Datasheet

### Technical Specifications

#### Three Phase 440V

	Model	Rated Power kW (HP)	Carrier Frequency (kHz)	Input Current (A)	Output Current (A)	Contactor (A)	Fuse/ MCCB (A)	Dimensions		
								Width	Height	Depth
Three Phase 440V	HD2-3.7A-43	1.5 (2)	8	5	3.7	10	17.4/16	126	186	184.4
	HD2-5A-43	2.2 (3)	8	5.8	5	10	17.4/16	126	186	185
	HD2-9.5A-43	4 (5.5)	8	13.5	9.5	16	30/25	126	186	200.9
	HD2-14A-43	5.5 (7.5)	8	19.5	14	16	45/25	126	186	200.9
	HD2-18.5A-43	7.5 (10)	8	25	18.5	25	60/40	146	256	191.9
	HD2-25A-43	11 (15)	8	32	25	32	78/63	170	320	219.2
	HD2-32A-43	15 (20)	4	40	32	50	105/63	170	320	219.2
	HD2-38A-43	18.5 (25)	4	47	38	63	114/100	200	340.6	207.2
	HD2-45A-43	22 (30)	4	56	45	80	138/100	200	340.6	207.2
	HD2-60A-43	30 (40)	4	70	60	95	186/125	250	400	222.4
	HD2-75A-43	37 (50)	4	80	75	120	228/160	250	400	222.4
	HD2-92A-43	45 (60)	4	94	92	135	270/200	282	560	257.1
	HD2-115A-43	55 (75)	4	128	115	170	315/200	282	560	257.1
	HD2-150A-43	75 (90)	2	160	150	230	420/250	282	560	257.1
	HD2-180A-43	90 (125)	2	190	180	280	480/315	338	554	329.2
	HD2-215A-43	110 (150)	2	225	215	315	630/400	338	554	329.2
	HD2-260A-43	132 (175)	2	265	260	380	720/400	500	870	360
	HD2-305A-43	160 (215)	2	310	305	450	870/630	500	870	360
	HD2-340A-43	185 (250)	2	345	340	580	1110/630	500	870	360
	HD2-380A-43	200 (270)	2	385	380	580	1110/630	500	870	360
	HD2-425A-43	220 (300)	2	430	425	630	1230/800	750	1410	380
	HD2-480A-43	250 (335)	2	485	480	700	1380/800	750	1410	380
	HD2-530A-43	280 (375)	2	545	530	780	1500/1000	750	1410	380
	HD2-600A-43	315 (420)	2	610	600	900	1740/1200	750	1410	380
	HD2-650A-43	355 (475)	2	625	650	960	1860/1280	620	1700	560
	HD2-720A-43	400 (535)	2	715	720	1035	2010/1380	620	1700	560
	HD2-820A-43	450 (600)	2	840	820	1222	2445/1630	620	1700	560
	HD2-860A-43	500 (670)	2	890	860	1290	2505/1720	620	1700	560

### Dimensions (mm) & Frame Sizes

Model	Width	Height	Depth	Frame Size
HD2-3.7A-43	126	186	184.4	1
HD2-5A-43	126	186	185	
HD2-9.5A-43	126	186	200.9	2
HD2-14A-43	126	186	200.9	
HD2-18.5A-43	146	256	191.9	3
HD2-25A-43	170	320	219.2	4
HD2-32A-43	170	320	219.2	
HD2-38A-43	200	340.6	207.2	5
HD2-45A-43	200	340.6	207.2	
HD2-60A-43	250	400	222.4	6
HD2-75A-43	250	400	222.4	
HD2-92A-43	282	560	257.1	7
HD2-115A-43	282	560	257.1	
HD2-150A-43	282	560	257.1	
HD2-180A-43	338	554	329.2	8
HD2-215A-43	338	554	329.2	
HD2-260A-43	500	870	360	9
HD2-305A-43	500	870	360	
HD2-340A-43	500	870	360	
HD2-380A-43	500	870	360	10
HD2-425A-43	750	1410	380	
HD2-480A-43	750	1410	380	
HD2-530A-43	750	1410	380	11
HD2-600A-43	750	1410	380	
HD2-650A-43	620	1700	560	
HD2-720A-43	620	1700	560	11
HD2-820A-43	620	1700	560	
HD2-860A-43	620	1700	560	

# HD2 Series

## AC Variable Speed Inverters



Technical Datasheet

### Dimensions (mm) & Frame Sizes

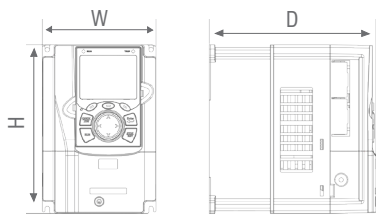

Frame Size 1

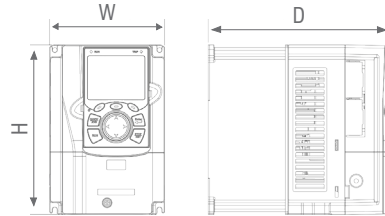

Frame Size 2

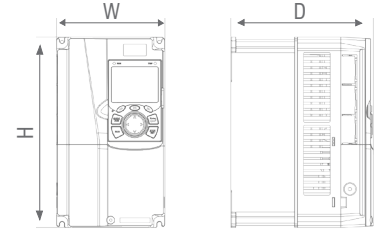

Frame Size 3

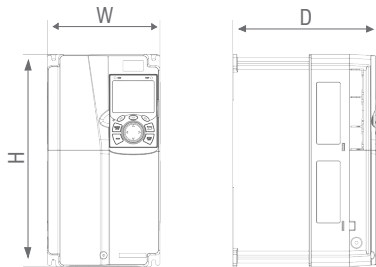

Frame Size 4

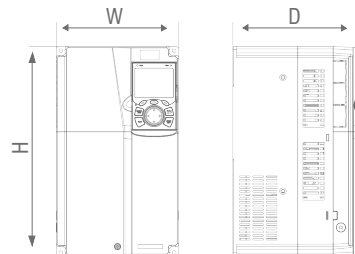

Frame Size 5

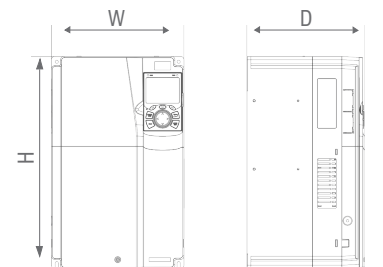

Frame Size 6

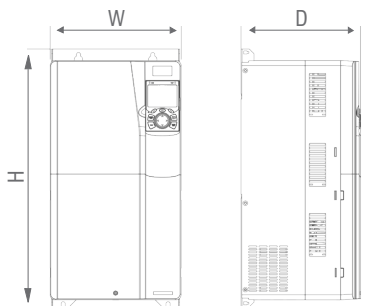

Frame Size 7

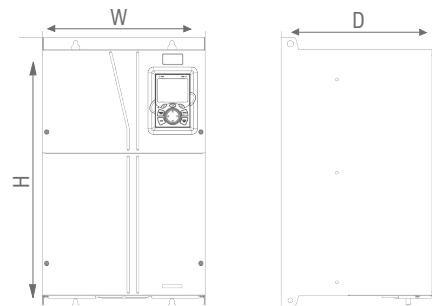

Frame Size 8

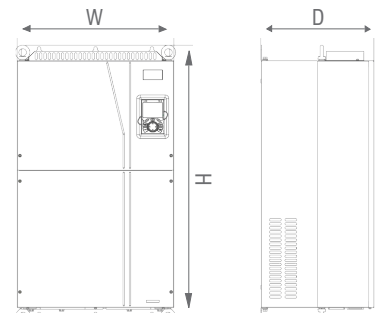

Frame Size 9

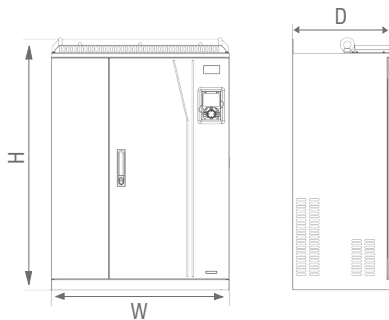

Frame Size 10

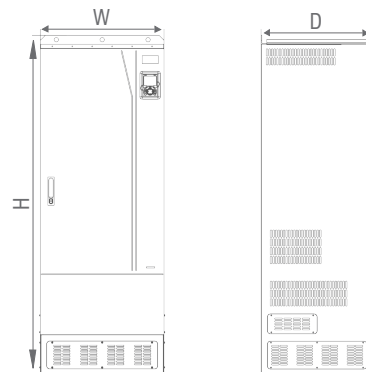

Frame Size 11

# HD2 Series

## AC Variable Speed Inverters

### Control Connections

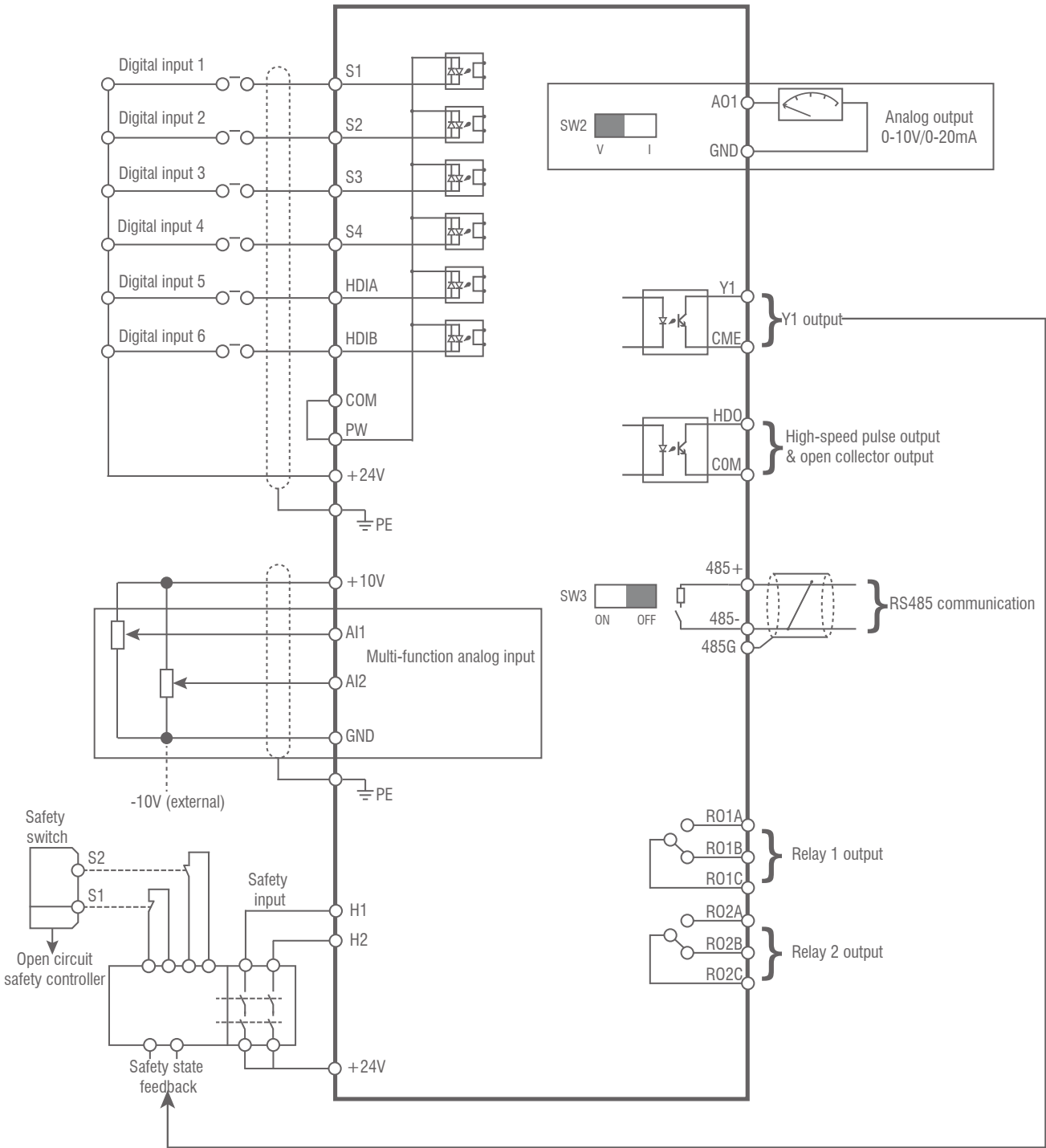

# HD2 Series

## AC Variable Speed Inverters



### Technical Datasheet

#### Accessories

Inverter	Input Reactor	DC Reactor	Output Reactor	Braking unit
HD2-3.7A-43	ACLCL-1.5-4	N/C	OCLC-1.5-4	Integral
HD2-5A-43	ACLCL-2.2-4	N/C	OCLC-2.2-4	Integral
HD2-9.5A-43	ACLCL-4.0-4	N/C	OCLC-4.0-4	Integral
HD2-14A-43	ACLCL-5.5-4	N/C	OCLC-5.5-4	Integral
HD2-18.5A-43	ACLCL-7.5-4	N/C	OCLC-7.5-4	Integral
HD2-25A-43	ACLCL-11-4	N/C	OCLC-11-4	Integral
HD2-32A-43	ACLCL-15-4	N/C	OCLC-15-4	Integral
HD2-38A-43	ACLCL-18-4	Integral	OCLC-18-4	Integral
HD2-45A-43	ACLCL-22-4	Integral	OCLC-22-4	Integral
HD2-60A-43	ACLCL-37-4	Integral	OCLC-37-4	Integral
HD2-75A-43	ACLCL-37-4	Integral	OCLC-37-4	Integral
HD2-92A-43	ACLCL-45-4	Integral	OCLC-45-4	DBU45/75-4
HD2-115A-43	ACLCL-55-4	Integral	OCLC-55-4	DBU45/75-4
HD2-150A-43	ACLCL-75-4	Integral	OCLC-75-4	DBU45/75-4
HD2-180A-43	ACLCL-110-4	Integral	OCLC-110-4	DBU90/110-4
HD2-215A-43	ACLCL-110-4	Integral	OCLC-110-4	DBU90/110-4
HD2-260A-43	ACLCL-160-4	DCLC-132-4	OCLC-200-4	DBU132-4
HD2-305A-43	ACLCL-160-4	DCLC-160-4	OCLC-200-4	DBU160/200-4
HD2-340A-43	ACLCL-200-4	DCLC-200-4	OCLC-200-4	DBU160/200-4
HD2-380A-43	ACLCL-200-4	DCLC-220-4	OCLC-200-4	DBU160/200-4
HD2-425A-43	Integral	DCLC-280-4	OCLC-280-4	DBU220/250-4
HD2-480A-43	Integral	DCLC-280-4	OCLC-280-4	DBU220/250-4
HD2-530A-43	Integral	DCLC-280-4	OCLC-280-4	DBU160/200-4 (x2)
HD2-600A-43	Integral	DCLC-315-4	OCLC-350-4	DBU160/200-4 (x2)
HD2-650A-43	Integral	DCLC-400-4	OCLC-350-4	DBU160/200-4 (x2)
HD2-720A-43	Integral	DCLC-400-4	OCLC-400-4	DBU160/200-4 (x2)
HD2-820A-43	Integral	DCLC-500-4	OCLC-500-4	DBU160/200-4 (x2)
HD2-860A-43	Integral	DCLC-500-4	OCLC-500-4	DBU220/250-4 (x2)

#### Expansion Card Selection

Expansion Card Type	Part Number	Part Description
I/O Card	HD2-E-IO	IO Expansion Card (4DI, 1 DO, 1 AI, 1 AO, 2RO)
	HD2-E-IO2	IO Expansion Card (1 PT100, 1 PT1000, 4 DI, 2 RO)
PLC Card	HD2-E-PLC	Programmable Expansion Card (CODESYS)
Communication Card	HD2-E-BTP	Bluetooth Communication Card (Internal Antenna)
	HD2-E-BTM	Bluetooth Communication Card (External Antenna)
	HD2-E-ENET	Ethernet Communication Card
	HD2-E-EIP	Ethernet/IP Communication Card
	HD2-E-ECAT	EtherCAT Communication Card
	HD2-E-WFP	WiFi Communication Card (Internal Antenna)
	HD2-E-WFM	WiFi Communication Card (External Antenna)
	HD2-E-COP	CANopen Communication Card
	HD2-E-CAN	CAN Master-Slave Communication Card
	HD2-E-PDP	PROFIBUS-DP Communication Card
	HD2-E-PRF	PROFINET Communication Card
	HD2-E-MTCP	Modbus TCP Communication Card
PG Card	HD2-E-PGIM	Multi-Function Incremental PG Card
	HD2-E-PGIM-24	24V Multi-Function Incremental PG Card
	HD2-E-PGI	5V Differential PG Card
	HD2-E-PGR	Rotary Transformer PG Card
Power Supply Card	HD2-E-APS	24V DC Aux. Power Supply Card
Accessories	HD2-KP	LCD Multi-function keypad
	HD2-KP-MB	Keypad mounting bracket