

Application-specific temperature sensors |

TGM 050-TS070

- Switches directly if the temperature threshold is exceeded
- 230 V AC
- Compact and robust design in stainless steel housing and with G 1/2 thread
- Temperature thresholds in the range from 60° C ... 100° C freely selectable ex factory
- For use in fluids
- For the protection of plant components and systems against overheating

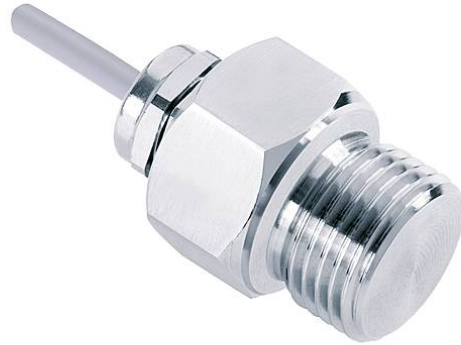

G1/2 - temperature threshold 70 °C

TYPE	TGM 050-TS070
Product ID	P71035
Response temperature	70 °C
Reset temperature range below threshold	30 +/-15 K
Tolerance	+/- 5 K
Process connection	G 1/2
Output	switching output
Switching voltage max.	230 VAC
Switching current max.	max. 2,5 cos φ = 1 / max. 1,6 cos φ = 0,6
Ambient temperature	-10 ... 80 °C
Medium temperature	-10 ... 120 °C
Compressive strength (at 25°C)	30 bar
Material sensor touched by medium	stainless steel AISI 316 Ti
Material housing	stainless steel AISI 316 Ti, brass-Ni
Protection [EN 60529]	IP 68 / IP 69
Protection [EN 60529] housing	IP 67
Electrical connection	2 m PVC-cable 2x0,5 mm ²

Technical Image

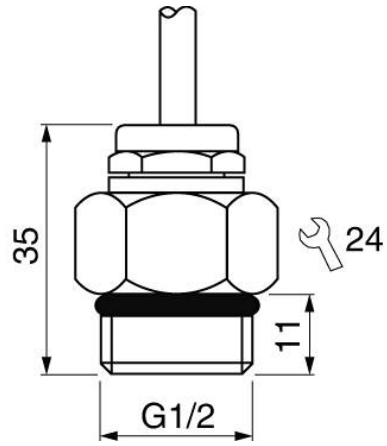

Pin Map

